



**FT PRO**

SEASON 2022  
COLLECTION



# FTPRO - 2022 OUR FAMILY



ALEX LUPATO



DENNY LUPATO



LAURA ROSSIN



FRANCESCO COLOMBO



JACK DODINO



MIRCO MONTAGNI



ERICH COSTANTINO



MATTEO CORSI



RICKY FADDA



TEAM BMT



TEAM ANCILLOTTI



GIGI

.....e MOLTI MOLTI ALTRI e siete tutti IL NS FUTURO!  
GRAZIE!!!!

FTPRO - 2022  
MUDGUARD - NUMBER PLATE

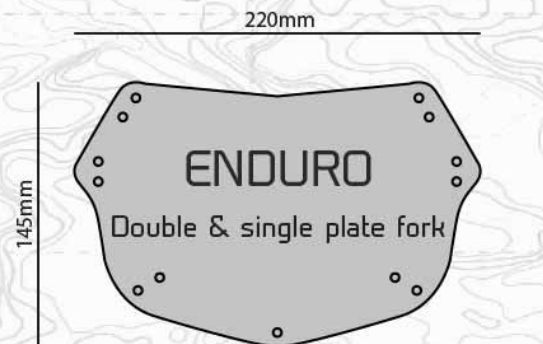
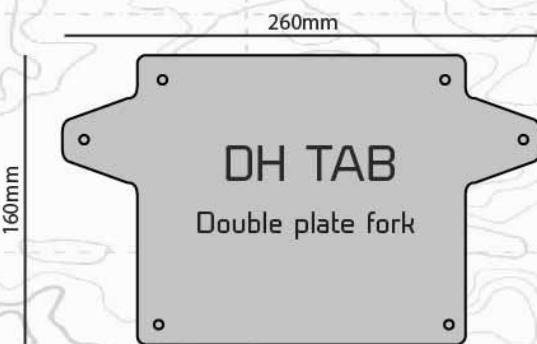
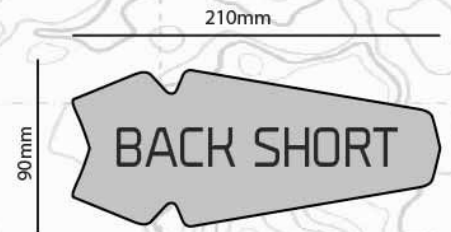
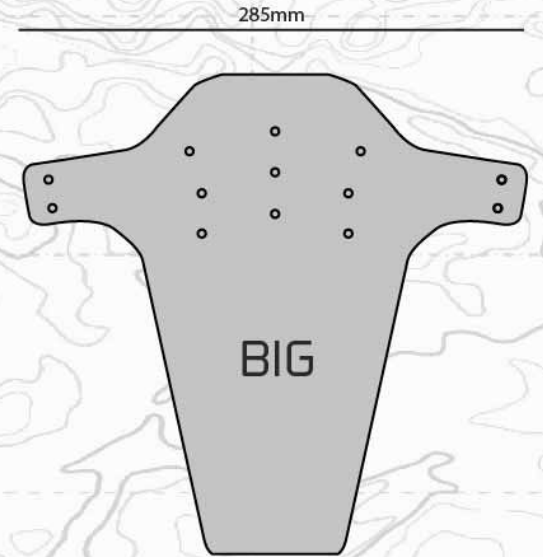
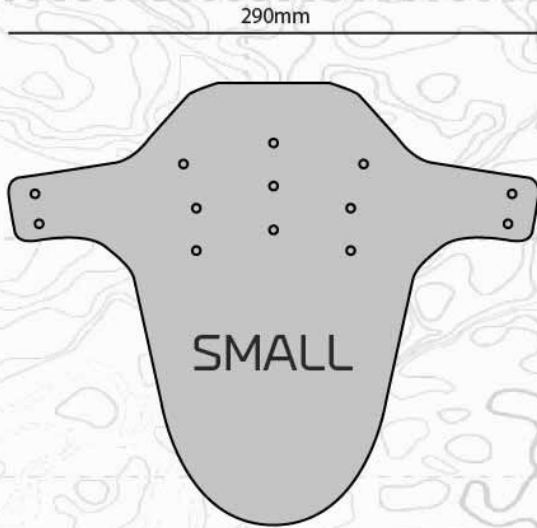
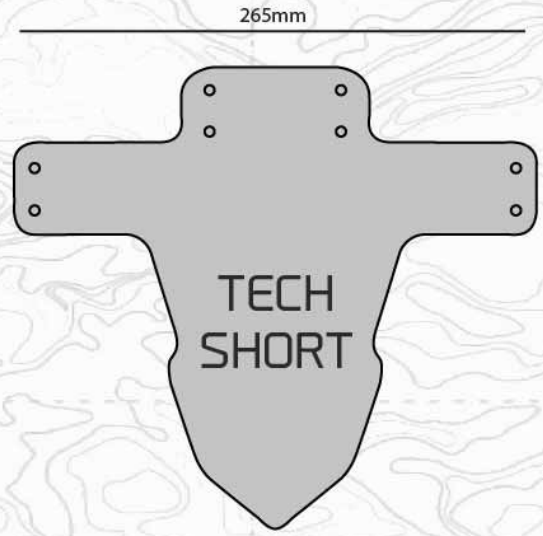
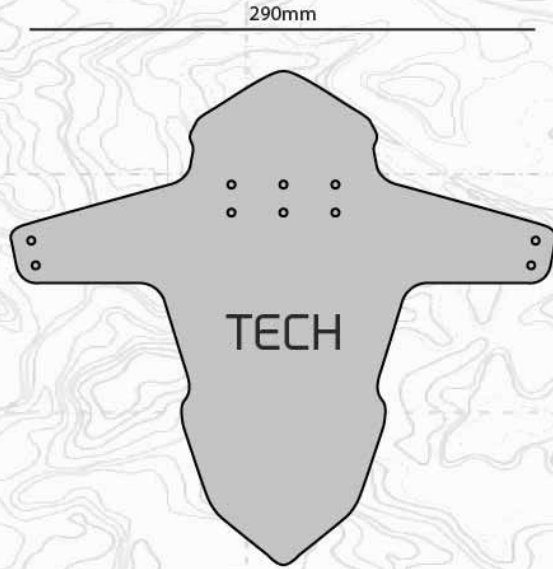

PHOTO: @carlodesantiphography

- Hole: 5mm
- Plastic thickness : 1mm
- Color Plastic background : Black
- 26" - 27.5" - 29"

# MODELS

Mudguard & Number plate



# COLORS

Mudguard & Number plate

MONO C.

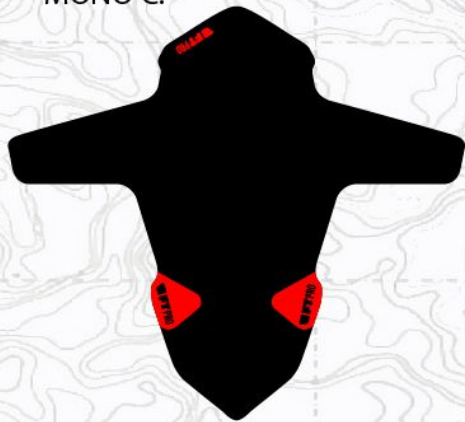

WHITE



RED



BLUE



YELLOW



ORANGE



DARK GREEN



GOLD



FUXIA



GREY



GREEN



CARTOON

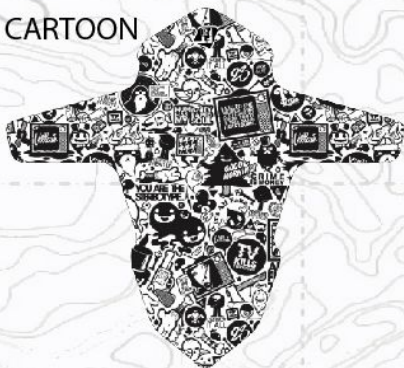

CARTOON GREY



CARTOON FUXIA



ZEBRA



CAMU

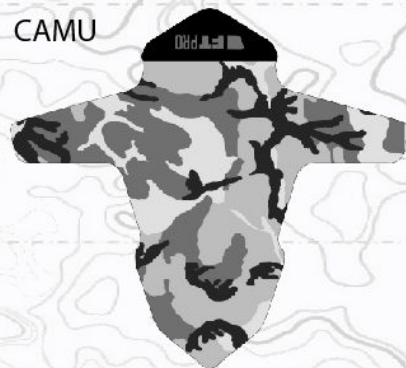

PIXELS



SKULL



SKULL COLOR



ROSE



# COLORS

Mudguard & Number plate

LOLLIPOP

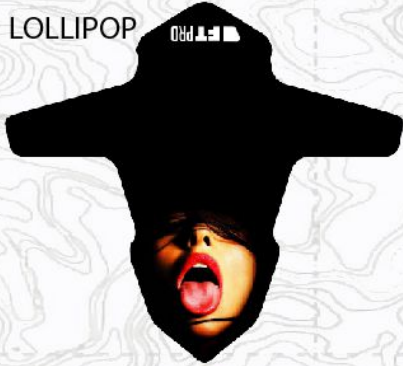

GIRL



MONKEY



SUNRISE

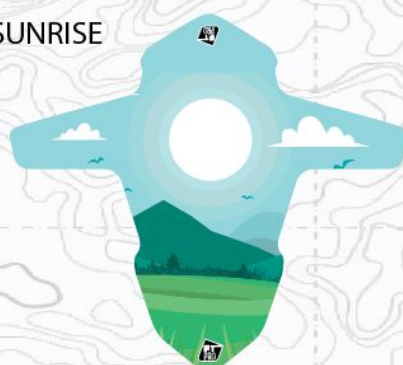

SUNSET



ARLY



PATATA



PIZZA



SPAGHETTI



CIAMBELLE



MUFFY



HAPPY



FLOWER



KISS



UNICORNO



# COLORS

Mudguard & Number plate

BANG



BANG GREY



VIPER



DEER



WOLF



BEAR



PALM



MOUNTAIN



KISS



HALOA



ENERGY



UFO



FTPRO - 2022  
ACCESSORIES





# EASY STRAP

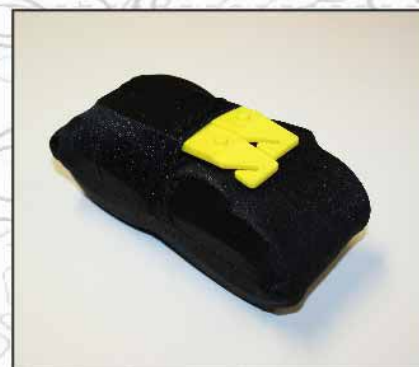
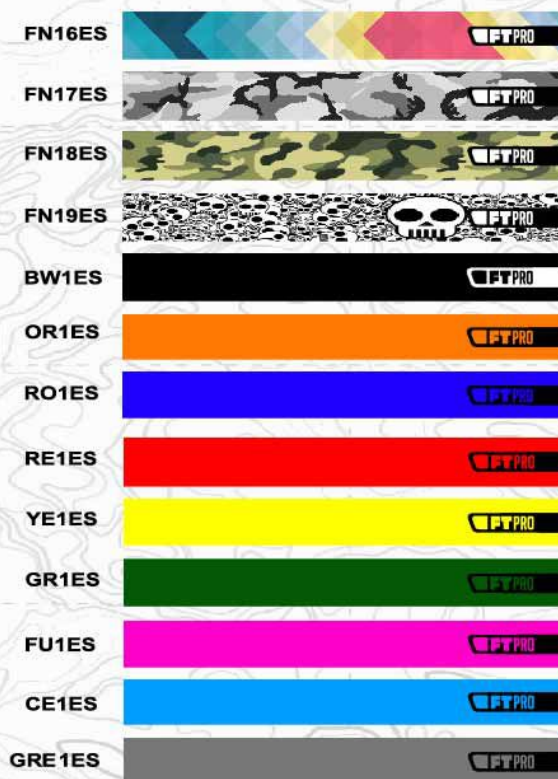

Fascia rigida per telaio e sottosella in tessuto Poli600D.

Viene fornita con una "calza" elastica per contenere tutto il necessario.

E' una soluzione pratica e compatta per attrezzi e kit di riparazione essenziali!

Può Contenere comodamente una camera d'aria ,smontacopertoni e 1 bombolette CO2.

Le fascia interna elastica permette di fissare al meglio i tuoi attrezzi.

DIMENSIONI: (50x3)cm

PESO: 45gr

Per le foto sono stati usati, Camera d'aria da

27,5" x 2.8, smontacopertoni standard ,

1 bombolette CO2 da (9x2x2)cm/Cad.

Questi articolo NON SONO COMPRESI!

Sono a puro scopo dimostrativo.

# FRAME BAG PRO



BW1FBP



FN17FBP



FN18FBP



FN16FBP



FN19FBP



BW4FBP



FN3FBP



TX6FBP



TX8FBP



TX7FBP



TX4FBP



TX9FBP



Astuccio/Frame Bag PRO per telaio e sottosella in tessuto Poli600D.

E' una soluzione pratica e compatta per attrezzi e kit di riparazione essenziali!

Può Contenere comodamente un Multi-Tools o 2 bombolette CO2, camera d'ariae smontacopertoni.

L'astuccio permette di avere una copertura al 90% della camera d'aria in modo da non esporla a sole, fango, acqua o altri agenti esterni.

Le fascie laterali elastiche dell'astuccio lo rendono adattabile ad ogni tipo di camera d'aria.

Grazie al Cinturini in Velcro ELASTICO si può fissare a qualsiasi telaio o in sospensione sotto alla sella anche con reggisella telescopici.

Sulla parte posteriore ha un tessuto antiscivolo che permette una maggiore aderenza al tubo del telaio.

DIMENSIONI: (14x6x5)cm

PESO: 89gr

Per le foto sono stati usati, Camera d'aria da 27,5" x 2.8, Multi-Tools da (10x3x2)cm , smontacopertoni standard , 2 bombolette CO2 da (9x2x2)cm/Cad.

Questi articolo NON SONO COMPRESI! Sono a puro scopo dimostrativo.

# FRAME BAG RECT

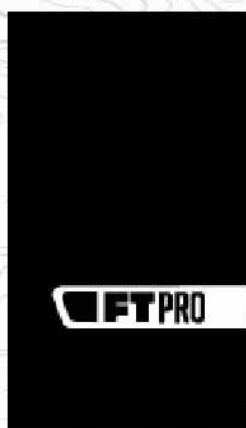

**BW1FBR**



**FN19FBR**



**FN16FBR**



**FN17FBR**



**FN18FBR**

Astuccio/Frame Bag RECT per telaio e sottosella in tessuto Poli600D e Neoprene SCUBA Elastico sul retro.

E' una soluzione pratica e compatta per attrezzi e kit di riparazione essenziali!  
Può Contenere comodamente un Multi-Tools o bombolette CO2, camera d'aria light, smontacopertoni ecc...

L'astuccio permette di avere una copertura al 100% degli accessori al suo interno.  
I cinturini in Velcro ELASTICO da una parte e in Velcro ricoperto in tessuto antiscivolo permettono il fissaggio sia sotto sella che su ogni parte del telaio o manubrio.  
Sul retro presenta una piccola fascia elastica per riporre esternamente piccoli accessori che non temono agenti esterno, come bombolette o smontacopertoni

DIMENSIONI: (10x13)cm  
PESO: 79gr

# TEAM BAG



I borsone TEAM è un accessorio iconico per molte buone ragioni, apprezzato da Rider e Team. Realizzato in Poliestere 600D idrorepellente, è incredibilmente robusto e resistente, molto pratico, con numerose caratteristiche studiate per renderlo il migliore amico di un rider. Usalo come borsone, trasportandolo con i due manici laterali o portalo in spalla durante gli spostamenti con la tracolla regolabile.

Ampia apertura superiore, due grandi tasche laterali e due tasche piatte al centro delle maniglie. E se non dovessero bastare, grande tasca sul fondo con apertura a doppio curose dove è alloggiata una vaschetta rigida in plastica dall'ampio volume per scarpe o vestiti sporchi. Se ci fosse una borsa simbolo di Rider senza metà, sarebbe questa.

Peso Medio: 1240 Gr

Capacità: 60 Litri

Tessuto: Tessuto POLIESTERE 600D

DIMENSIONI:

70 Cm X 33 Cm X 33 Cm (Corpo Superiore)

47 Cm X 26 Cm X 10 Cm (Tasca Inferiore con vaschetta)

12 / WHEELBAG TEAM doppia ruota

## WHEELBAG TEAM doppia ruota



Borsa Wheelbag per trasportare comodamente le tue DUE ruote!!!

Studiata per trasportare fino a ruote da 29pollici con copertoni da DH.

Proteggi e trasporta facilmente le tue ruote grazie al doppio scomparto.

Costruita in Poliestere 600 rinforzato con alta capacità di resistenza all'abrasione.

Le pareti esterne sono imbottite per viaggi sicuri e protezione totale.

Il divisorio interno è imbottito e con rinforzo centrale per evitare il contatto con l'asse del mozzo.

Tasca interna porta accessori o eventuali dischi supplementari.

Copri tracolla imbottito con possibilità di doppia regolazione e copri maniglia a chiusura con velcro.

Peso Medio: 1850 Gr

Capacità: 60 Litri

Tessuto: Tessuto POLIESTERE 600D

Dimensioni totale:

Diametro 77cm x Larghezza totale 26cm

Dimensioni singolo reparto:

Diametro 77cm x Larghezza 13cm

## TAZZA GOOD DAY



Tazza in ceramica , ottima per dare la carica alla mattina prima di una bella giornata in mountainbike!  
Stampa sublimatica su entrambi i lati.

DIMENSIONI: 9cm Altezza, 8 Cm Diametro  
CAPACITA': 325 ml

Si consiglia di lavare a mano.

## SHOPPER BAG

Borse Ideali per pacchi gara o vendita al dettaglio negozio

Codice  
11107



Codice  
16120



Borsa in TNT gr70 piatta termosaldata  
Dimensioni 36 X 40 CM

Borsa in TNT gr80 con soffiutto termosaldata  
Dimensioni 36 X 40 +9 CM

COLORS



\*loghi a scopo illustrativo / logos for illustrative purposes



PHOTO: Alessandro Avondo / @naiveagency  
RIDER: @LupatoBrothers

## ITALIA

FT TEXTILE di Fumagalli Tiziana  
Via Leopardi 7  
23900 LECCO  
P.IVA 03617790138  
fttextile@gmail.com  
WWW.FTPRO.IT